

swiss + made

# Surgical and Prosthetic Concept Tissue-Level Implant Z5-TL

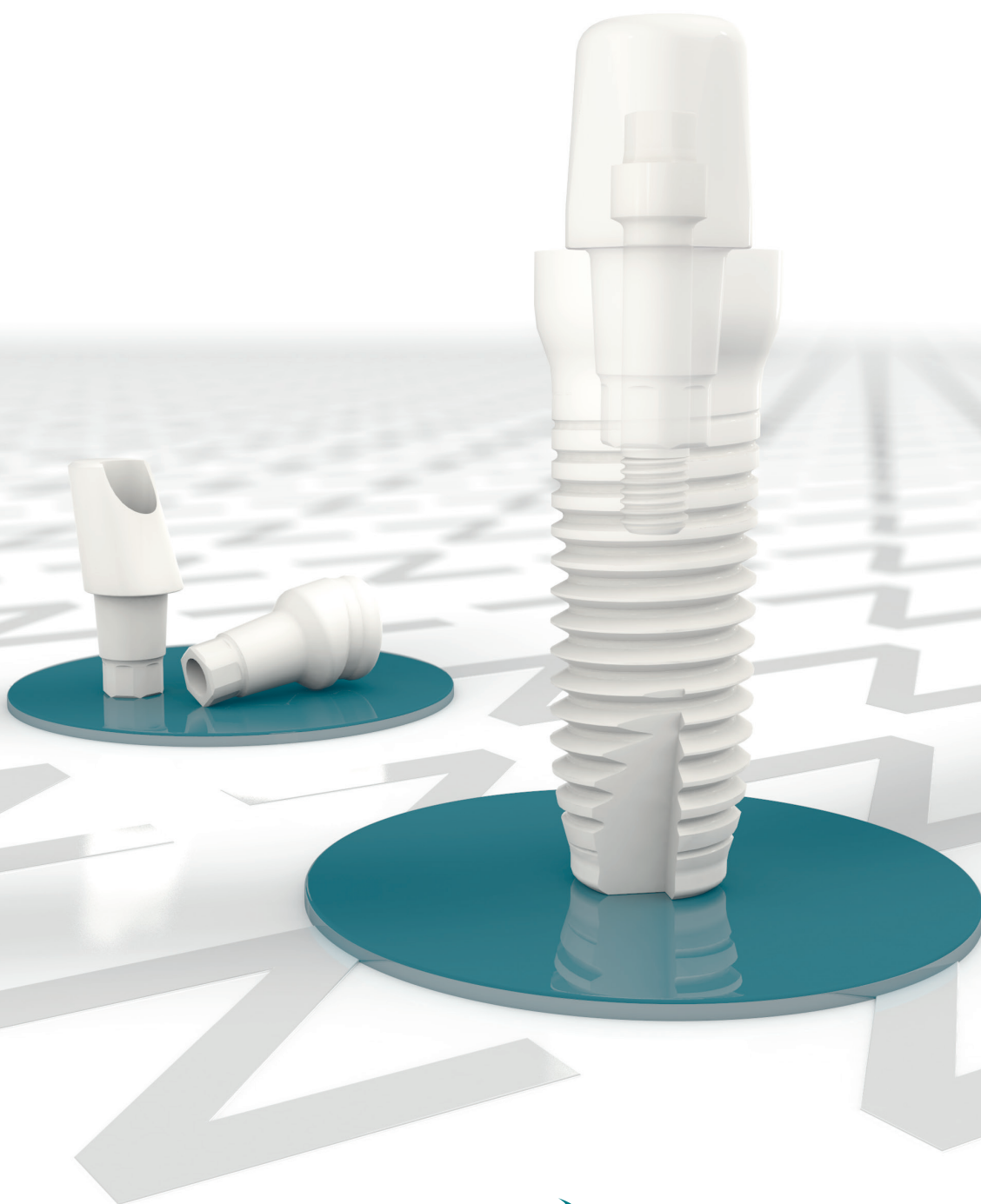

**Z-SYSTEMS**  
ceramic implants

## Welcome to the world of ceramic implants

**The Z-SYSTEMS implant system is the result of many years of clinical and laboratory experience since 2004. Safety is our foremost priority.**

This basic information on the surgical and prosthetic procedure of the Z-SYSTEMS Implant System is intended to provide dentists, physicians, surgeons and dental technicians with a description of the most important surgical and prosthetic steps for the planning, treatment and procedure of the Z-SYSTEMS System. This manual cannot replace implantological and prosthetic training. It is assumed that the user is familiar with the implant procedure.

1	General information	
1.1	General aspects and important information	6
1.2	Material, biocompatibility and osseointegration	8
1.2	Indications	10
1.4	Fundamentals of treatment planning	12
1.5	Protective measures	15
2	Surgery	
2.1	Instruments	18
2.2	Sterilisation	20
2.3	Surgical procedure / Drilling protocol	21
2.4	Drilling protocol	26
2.5	Specific features of Z5-TL	28
2.6	Removing the implant from the packaging	30
2.7	Postoperative recall protocol	32
3	Prosthetic concept	
3.1	Healing abutments	34
3.2	Fixing the abutment with Z5-TL implants	35
3.3	Impressions with the Z5-TL implant	37
3.4	Model fabrication	38
3.5	Temporary care of Z5-TL implants	39
3.6	Restoration with a laboratory-manufactured long-term temporary restoration after osseointegration	40
3.7	Final restorations on Z5-TL implants	41
3.8	Prosthetic restoration of Z5-TL implants	42
3.9	Prosthetic restoration of Z5-TL implants in the edentulous jaw	43
3.10	Prosthetic aftercare of the Z5-TL implants	46
3.11	Cementing of restorations on Z5-TL implants	47
3.12	Prophylaxis for Z5-TL implants	48
3.13	How to remove a ceramic screw fragment from a ceramic implant	49

# General aspects and important information

## General aspects

**Z-SYSTEMS implants are unique in their combination of design and material. We expressly ask you to read this manual thoroughly before starting planning and to exactly follow our specific instructions on preparation as well as surgical and prosthetic procedures.**

Observing these specific instructions and following the general implantological and prosthetic principles may help ensure successful implantation with Z-SYSTEMS implants.

The health of your patients is our top priority. For this reason we have compiled a technical guide that will contribute to the success of treatment with Z5-TL implants. The surgical and prosthetic phase should be preceded by extensive preoperative assessment, diagnosis and planning. Careful planning and adherence to the protocols for implantation and prosthetic restoration of Z5-TL implants reduces/avoids problems/errors during implantation and especially during prosthetic restoration.

We recommend the use of Z5-TL implants only for dentists with thorough, practical and surgical training and with expertise and experience in implantology. Instruction/training by an implantologist or Z-SYSTEMS representative familiar with the use of the instruments is strongly recommended. Z-SYSTEMS offers regular training courses with experienced users for starting with the system.

## Important information

**Disclaimer:** The Z5-TL implant system is part of an overall concept and may only be used in conjunction with the corresponding original components and instruments and according to the Z-SYSTEMS instructions and recommendations. Instructions regarding the application of our products are given verbally, in writing, electronically or through practical training, in accordance with the state of the art at the time of product launch. The user of Z5-TL products must decide whether or not a product is suitable for a patient and a specific situation according to their indication. Z-SYSTEMS excludes any liability for damages resulting from the use or implantation of Z5-TL products as a result of, or in connection with, errors in professional assessment or application/indication, in particular also claims due to the disregard of general implantological and prosthetic principles in connection with implants. The user is also obliged to inform themselves regularly about the latest developments of our system and its applications.

Send us an e-mail to support@zsystems.com and we will be happy to send you the latest information.

**Training:** We recommend exchanging experiences, learning from and with colleagues. Z-SYSTEMS offer its users and interested parties extensive options for continuous professional development. Z5-TL courses are offered with and without live surgery.

Information regarding all our courses can be found at [www.zsystems.com](http://www.zsystems.com) under «Events».

**Availability:** Not all of the products described in this manual are available in all countries. For further information, please contact our subsidiary or sales company in your country.

**Precautions:** Our products must be protected from aspiration during intraoral use.

**Delivery:** The sale of these products is limited to dentists, doctors or licensed dental technicians or orders made on their behalf.

**Units per package:** Unless otherwise stated, the package unit is 1 piece.

**Documentation:** Detailed instructions regarding the Z5-TL implant system are available from your account manager or customer service department in our headquarters.

**Qualified users:** Z-SYSTEMS implants should only be used by dentists, doctors, surgeons and dental technicians that are trained to use the system. Corresponding courses are offered by Z-SYSTEMS.

## Certification:

**FDA/CE/ISO13485/MDD93/42 EEC**













Z-SYSTEMS have complied fully since 2004 with the current normative and legal requirements for medical products through European certification according to ISO 13485, as well as the guideline 93 / 42 / EEC for medical devices. Z-SYSTEMS have been registered with the FDA (US Food and Drug Administration) since 2007.

## Color coding of the surgical and prosthetic products:

**Red:** 4.0 mm diameter

**Green:** 5.0 mm diameter

## Explanation of the symbols on labels and package inserts

	Medical Device
	Batch number
	Catalogue number
	Plasma sterilised
	Non-sterile
	Do not use if packaging is damaged
	Do not re-use, onetime use
	Caution: Observe the package inserts
	Consult the instructions for use
	Use before expiration date
	Date of manufacture
	Manufacturer
	CE marking is the manufacturer's declaration that the product meets the requirements of the applicable EC legislation. Where applicable: The identification number of the Notified Body shall follow this symbol.
<b>Rx only</b>	CAUTION! United States Federal Law restricts this device to sale to, or on the order of, a licensed dentist or physician.

Do not expose the products to direct sunlight.

## Material, biocompatibility and osseointegration

### Material

All Z5-TL implants are manufactured according to the unique "Zirkolith®" process from zirconium oxide Y-TZP bioceramics in compliance with the ISO 13356 standard - it encompasses our experience in the development, material processing, quality assurance and finishing of zirconium oxide. The composition and production processes for zirconium oxide vary according to the requirements for the system component, for example whether it is an implant, a cutting instrument or some other surgical instrument.

The material achieves its properties through the "Hot Iso-static Pressing" process. In this process, the material is recompressed in a tunnel kiln for three days at 2000bar after the sintering process, which improves the physical properties of the base material.

Not only the implants, but also the instruments that come into direct contact with the bony surgical area are made of zirconium oxide. The cutting instruments are made of high-strength ATZ high-performance ceramics (Alumina Toughened Zirconia).

### Biocompatibility

Numerous studies since the 1960s have confirmed the excellent biocompatibility of zirconium oxide ceramics.

### Osseointegration

Zirconium oxide has similar osseointegration behaviour to commercially pure titanium, which has also been proven in a large number of studies.

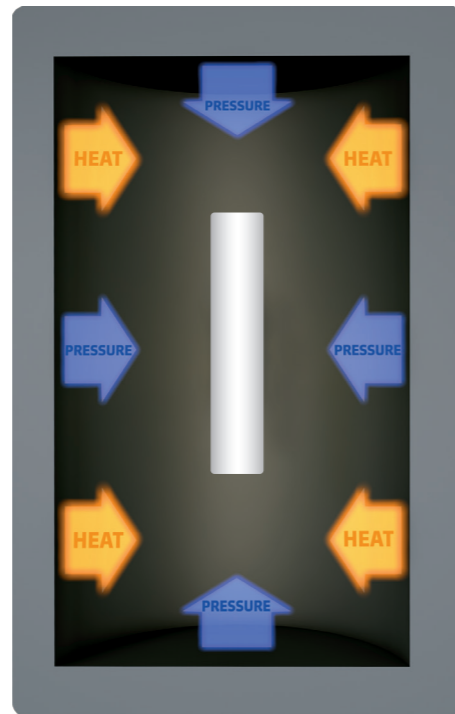

Hot Iso-static Pressing in a tunnel kiln:  
Pressure up to 2000 bar, temperatures up to 2000°C

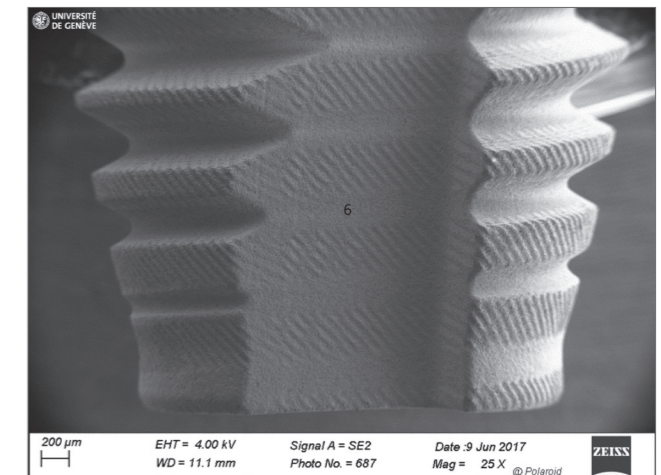
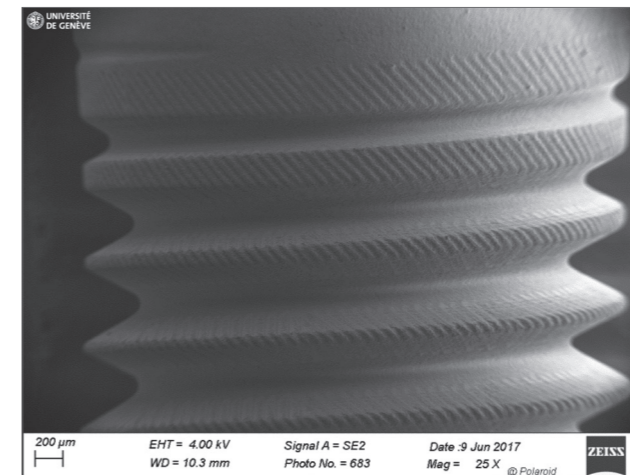

### Surface

Surface modification is made in the SLM® process developed by Z-SYSTEMS using laser technology and results in an increase in surface area and therefore to increased macro and micro roughness.

### Healing time

We recommend a healing time of 3 months in the lower jaw and 6 months in the upper jaw\* for healthy patients with good bone density and sufficient bone quality.

We strongly recommend that each implant is protected during the healing phase, for example through provisional arrangements or ground prostheses.

\* Please note that all references to bone classification in this manual refer to the classification as described by Lekholm and Zarb: Lekholm U.R. & Zarb G.A.: Patient selection and preparation, in Brånemark P.-I., Zarb G.A., Albrektsson T. (eds): Tissue-Integrated Prostheses: Osseointegration in Clinical Dentistry. Chicago IL, Quintessence, 1985, PP 199-209.

# Indications

Z5-TL implants are designed for surgical implantation into the upper and lower jaw for the attachment of prosthodontic appliances to replace missing teeth. Z5-TL

implants are suitable for patients with metal allergies and the chronic diseases resulting from them. Z5-TL implants are intended for delayed loading.

### General areas of application

As a rule of thumb, the implant with the largest possible diameter should always be used, because the mechanical strength increases disproportionately with increasing diameter of the implant.

### 4.0 mm application

Universal implant that is suitable for most indications. Not suitable for applications where there is a risk of excessive bending moments (e.g. extended crowns, extension bridges, bridges with more than one pontic). Limited suitability for telescopic restorations. Use for telescopic restorations is only recommended for one-piece implants and require special planning. Telescopic or Locator-type abutment restoration on at least 4 implants in the mandibular and 6 implants in the maxilla is recommended.

### 5.0 mm application

Universal implant, suitable for most indications where there is sufficient bone. Not suitable for applications where there is a risk of excessive bending moments (e.g. extended crowns, extension bridges, bridges with more than one pontic). Implants with Ø 5.0 mm are recommended for the indication canines, central upper incisors and upper jaw/lower jaw molars. Limited suitability for telescopic restorations. Use for telescopic restorations is only recommended for one-piece implants and require special planning. Telescopic or Locator-type abutment restoration on at least 4 implants in the mandibular and 6 implants in the maxilla is recommended.

Implant size	Thread diameter	Shoulder diameter	Minimum space requirements rovestibular (surgery)	Minimum space requirements mesio-distal (surgery)	Optimum indication odontogram	Single-tooth	Blocking	Bridge in premolar width (max. span 1 pontic)	Extension bridge	Bar	Telescope	
4.0	4.0 mm	4.8 mm	6.0 mm	7.0 mm	UPPER RIGHT   1st Quadrant	UPPER LEFT   2nd Quadrant	+	+	+	-	+	(+)
					USA 2 3 4 5 6 7 8	9 10 11 12 13 14 15						
					FDI 17 16 15 14 13 12 11	21 22 23 24 25 26 27						
					USA 47 46 45 44 43	33 34 35 36 37						
USA 31 30 29 28 27	22 21 20 19 18											
5.0	5.0 mm	6.0 mm	7.0 mm	8.0 mm	UPPER RIGHT   1st Quadrant	UPPER LEFT   2nd Quadrant	+	+	+	-	+	(+)
					USA 2 3 4 5 6 7 8	9 10 11 12 13 14 15						
					FDI 17 16 15 14 13 12 11	21 22 23 24 25 26 27						
					USA 47 46 45 44 43	33 34 35 36 37						
USA 31 30 29 28 27	22 21 20 19 18											

+ recommended | (+) not recommended | - not possible

## Fundamentals of treatment planning

**The patient must meet the generally valid implant surgery and prosthetic criteria for an implant restoration.**

Implant prosthetic restoration is a collaboration involving the dentist/surgeon and dental technology and requires a high degree of clinical experience and detailed knowledge from all involved.

### The following are important planning points:

Z-SYSTEMS recommend the selection of the appropriate implant and its restoration according to the following criteria:

- Endosseous diameter of the implant
- Shoulder diameter of the implant
- Length of the implant
- Vertical implant position

### Aesthetically optimum result

Many conditions are decisive for an aesthetically optimum result:

- the harmonious course of the gingiva
- the best implant position (vertical, orofacial and mesio-distal)
- the shape of the crown and
- the presence of interdental papillae

### Planning the position of the implant

During planning, the instructions for the hard tissue configurations are to be complied with and soft tissue management must be observed.

The implant diameter and implant length must be determined so that there is sufficient bone (at least 1 mm) around the implant. A minimum distance of 1.5 mm to an adjacent natural tooth and 3 mm to an adjacent implant must be maintained.

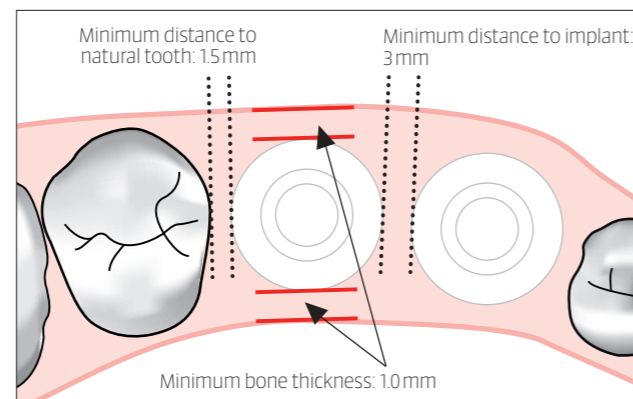

Structure-preserving and structure-protecting procedures are to be used for flap design and implant placement. The oral hygiene requirements must be taken into account as early as the planning stage.

## Restorations

### Single-tooth crowns

Restoration with single crowns is a possible restoration under the aspect of "restitutio ad integrum". It includes all the advantages that are possible in periprosthetic rehabilitation.

The physiologically adequate biomechanical load prevents further atrophy of the hard and soft tissue.

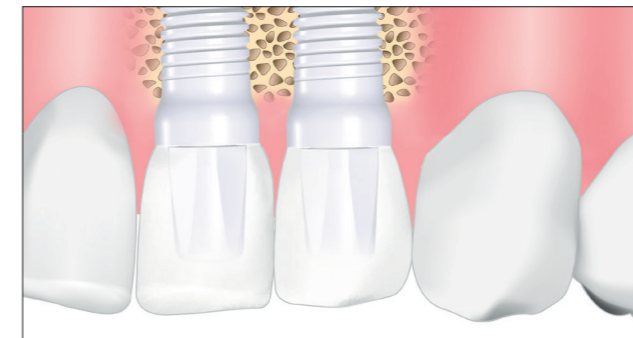

### Blocked crowns

Blocking of the crowns may be necessary for static reasons (such as unfavourable lever ratios). When selecting blocking, the possibility to maintain good hygiene must be considered.



### Implant-supported bridges

Implant-supported bridges can be inserted in positions that do not permit implant placement. The implant distribution must be selected so that small span segments are created.



### Zloc prosthetic restoration

Zloc abutments are used to attach prostheses in the restoration of the edentulous upper or lower jaw.

- The all-on-four treatment concept is to be observed
- Avoidance of axis divergence

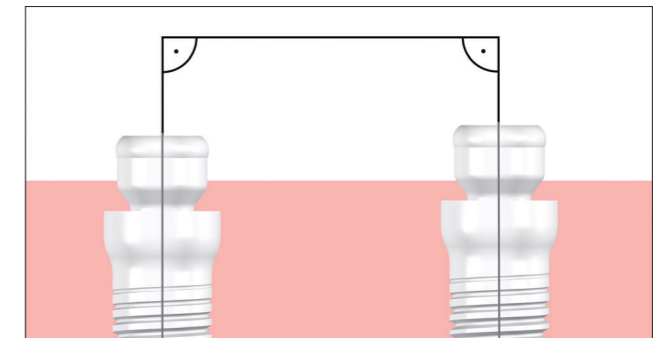

### Planning the implant position for Zloc restorations

**CAVE:** To ensure trouble-free function of the retentions and avoid loading the implants beyond their stability, an axial transfer of force to the implants should be ensured as far as possible. For this purpose, the implants should be positioned as parallel to each other and perpendicular to the occlusal plane as possible. The implants should be placed on the same horizontal plane if possible to allow easy handling when removing or inserting the prosthesis.

#### Guided surgery

Z-SYSTEMS recommends case planning using three dimensional X-ray images (DVT/CT) and the use of a drilling template produced on the basis of this planning in the sense of "guided surgery" to ensure that the axial alignment of the Z5-TL implants is as parallel as possible.

#### Gingiva height

Before surgery measure the maximum tissue thickness at the planned implantation site (e.g. using a probe and attached measuring stop root canal instrument, local anaesthesia).

#### Implant divergence

Z-SYSTEMS recommends an optical check of the axis alignment for parallelism after pilot drilling using the DP230 depth gauge.

With straight or angled Zloc abutments, the maximum divergence between several implants is 30°. If there is a divergence between the load (perpendicular to the occlusal plane) and implant axis of more than 15° per implant, or more than 30° between several implants, the axial alignment of the implant must be corrected.

The functional area of the Novaloc™ matrix is 1.35 mm (1.85 mm if the overdenture is to be made with 0.5 mm gingiva clearance) above the surrounding gingiva to ensure the trouble-free function of the Novaloc™ matrix.

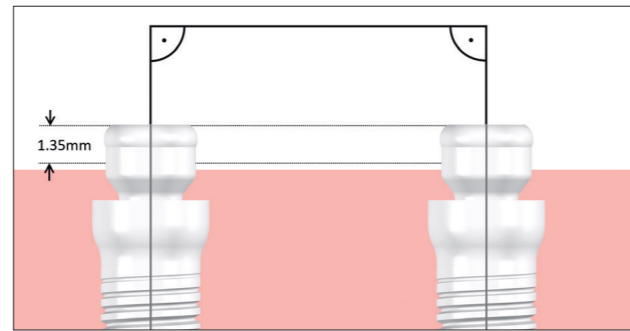

Avoidance of axis divergence

#### Zloc gingiva height

Zloc abutments have different abutment heights (AH). The implant has a gingiva height (GH) of 2.5 mm. Therefore, the total gingiva height consists of the implant GH and Zloc AH.

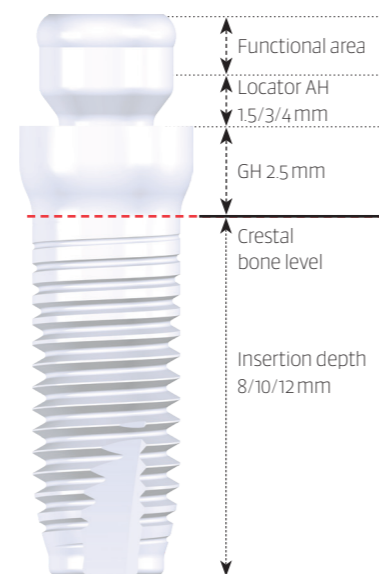

## Protective measures

For successful osseointegration, the implants must be protected from macro movements during the healing phase. Depending on bone quality, insertion torque, periosteal measurement and general patient compliance, the dentist decides whether and which additional protective measures are necessary. Possible protective measures are: protective splints, blocked temporary restorations or protective prostheses.

Examples of protective measures are available on request from support at [support@zsystems.com](mailto:support@zsystems.com).

## 2 Surgery

2.1	Instruments	18
2.2	Sterilisation	20
2.3	Surgical procedure / Drilling protocol	21
2.4	Drilling protocol	26
2.5	Specific features of Z5-TL	28
2.6	Removing the implant from the packaging	30
2.7	Postoperative recall protocol	32

# Instruments

The Z5-TL surgery cassette from Z-SYSTEMS is to be used.

The instruments required for implantation have been designed to be user-friendly. The rotating instruments are marked with a color code throughout. The instruments are labelled with the respective instrument designation to avoid any risk of confusion. The drills are arranged in the cassette according to the treatment sequence.

## Driver

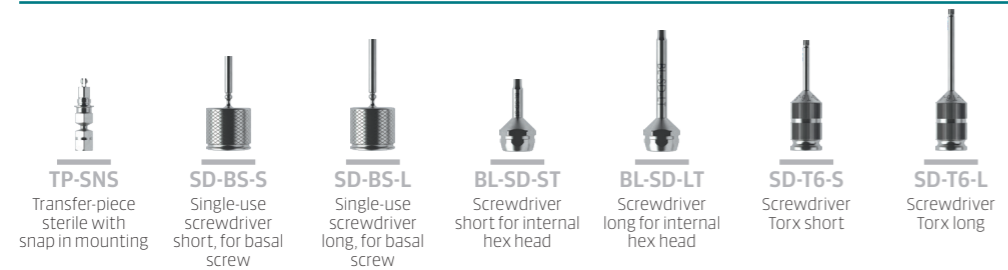

## Gauges



**Meaning of the colors:**  
red =  $\varnothing$  4 mm, green =  $\varnothing$  5 mm

## Material properties

All instruments that come into direct contact with the surgical field are made of zirconium oxide. The cutting instruments are made of high-strength ATZ high-performance ceramic (Alumina Toughened Zirconia).

This alumina-reinforced zirconium oxide is ideal for the manufacture of drills and taps. The ATZ drills cut excellently with very little wear. Note: The drills must be examined after every use for blunt cutting edges or damage and if necessary, exchanged.

## Drills

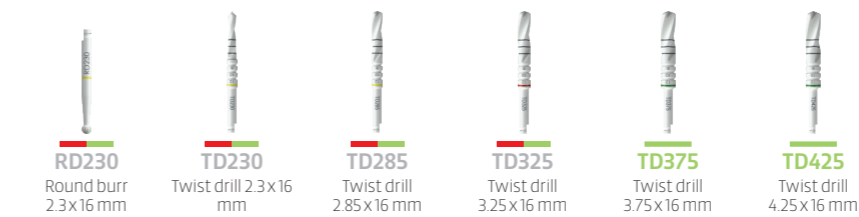

## Cortical drill



## Counter-sinks



## Tap



## Adapter for tap

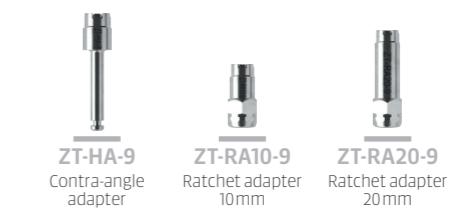

## Ratchet



## Accessories



## Sterilisation

### Sterilisation in a steam steriliser/autoclave

Use steam sterilisation processes with a fractionated vacuum process (and sufficient product drying). Other sterilisation methods (including gravitational steam sterilisation) are not permitted. Pay attention that:

- the sterilisation temperature does not exceed 138°C/280°F (plus tolerance according to EN ISO 17665-1).
- EU: the sterilisation holding time (exposure time at sterilisation temperature) is at least 4 minutes at a minimum temperature of 134°C/273°F.
- USA: the exposure time is 4 minutes at 132°C/270°F.

All zirconia abutments and abutment screws are sterilized unwrapped and are to be used immediately (do not store).

Healing abutments and temporary abutments are to be wrapped in a sterilization wrap that is FDA-cleared for the indicated cycle, and dried for 30 minutes.

## Surgical procedure / Drilling protocol

### General drilling protocol

#### General note:

##### Round burr

To predrill the cortical bone fix the implant position.

##### Twist drill

The implant bed is prepared with the twist drills in ascending order. The last drill used depends on the diameter of the implant to be inserted. Please follow the detailed instructions. The depth markings on the drill are easy to read. The first depth mark is 8 mm.

**CAVE:** The apical excess length of the drill tip is maximum 0.8 mm longer than the insertion depth of the implant. Please take this into account during the drilling process.

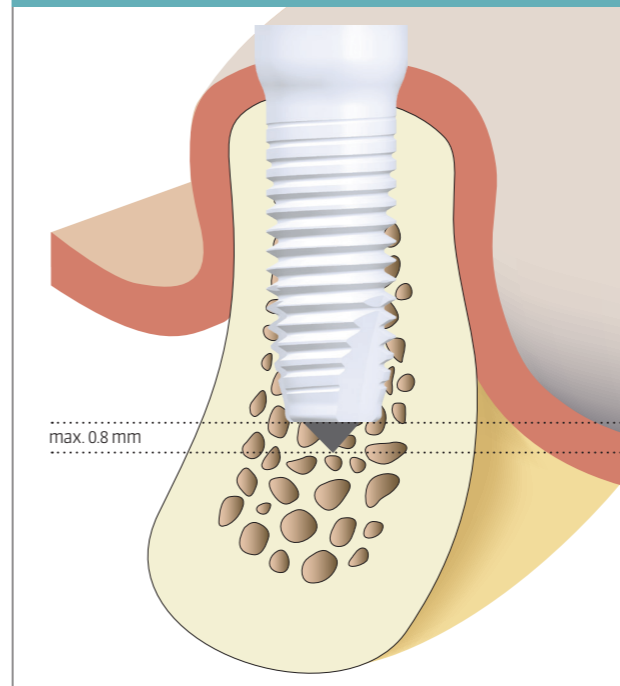

#### Drill stops

Drill stops are available for twist drills and cortical drills in the respective diameters. These are attached to the corresponding drills from the contra-angle handpiece connection side in the direction of the arrow and fixed at the required drilling depth. To remove, simply pull off in the direction of the arrow.

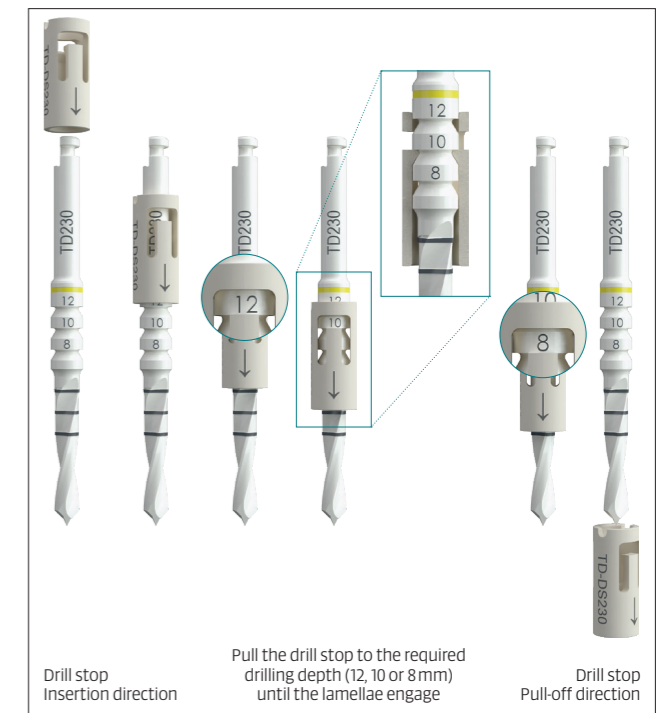

#### Cortical drill

Cortical drills are available to expand the cortical area according to the implant diameter. The use of a cortical drill is expressly recommended for cases with hard bone or cortical bone.

#### Tap

In principle, all Z5-TL implants are self-tapping. The use of a tap is recommended for cases with hard bone or hard cortical bone.

**The general recommendations are:**

Bone class D1+D2:

- Cortical area expansion with the cortical drill up to the depth marking
- Tap the entire length

Bone class D3+D4: do not tap

**Exemplary procedure: Preparing the implant bed**

The following shows how to prepare the implant bed using the example of a  $\varnothing$  4.0 mm/10 mm Z5-TL implant in hard bone (D1).

After unfolding the gingiva, the basic preparation of the implant bed begins with preparation of the alveolar ridge and marking the implantation site with a round burr (RD230). This is followed by the pilot drill with the spiral drill (TD230) and the further preparation of the implant bed using the spiral drills in accordance with the endosteal implant diameter.

The threads are pre-cut with the tap; please refer to the notes on the previous page.

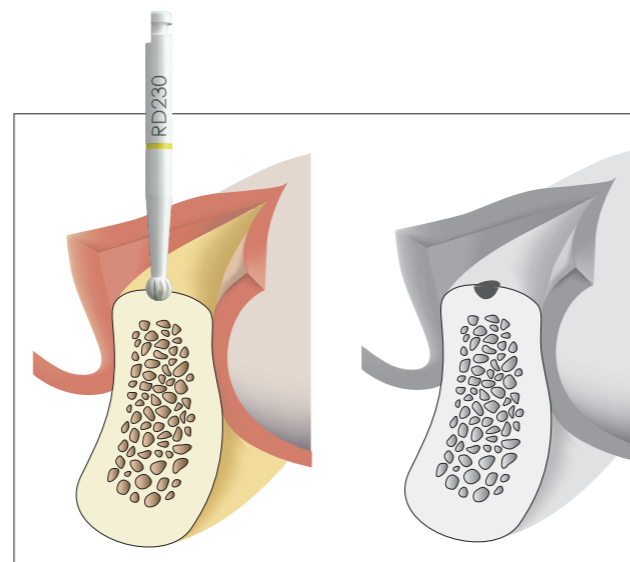
**1. Preparation of the alveolar ridge and marking of the implantation site**

Carefully reduce and smooth a narrow and tapered alveolar ridge with the RD230 round burr. This results in obtaining a flat and sufficiently wide bone surface. Mark the implantation site determined during the planning of the implant position with the RD230 round burr.

*Note: Depending on the clinical situation, this step may be omitted or applied in a modified form (e.g. for fresh extraction sockets).*

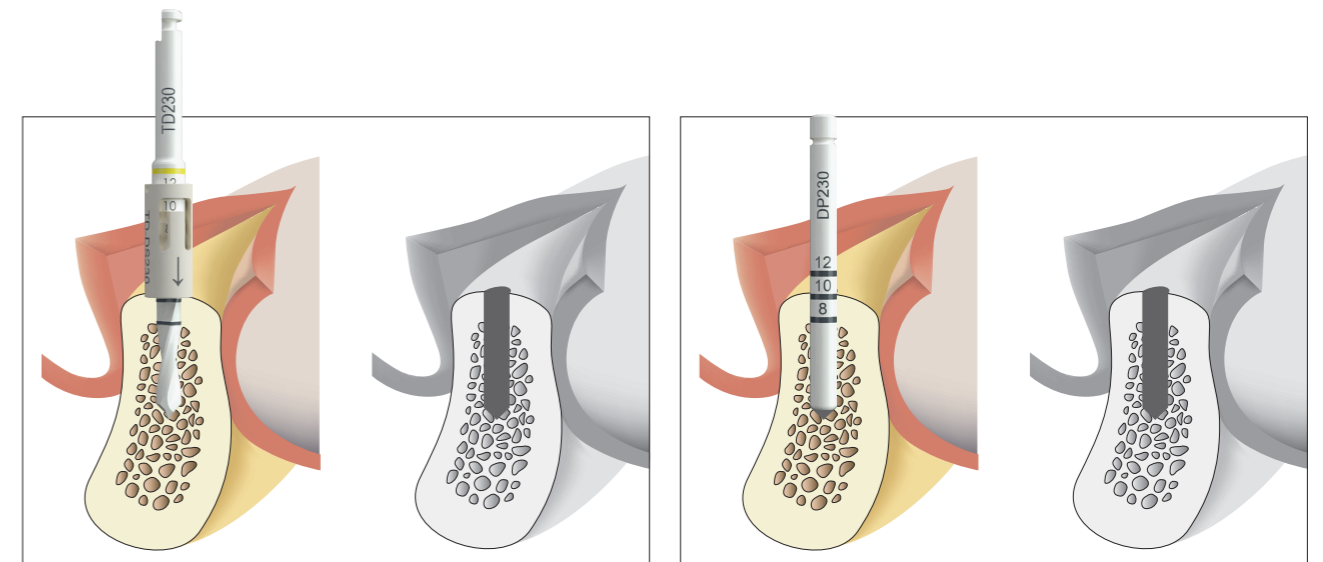
**2. Implant axis and depth**

Use the twist drill TD230 to mark the implant axis by drilling to a depth of approximately 5 mm. Use the depth gauge DP230 to check the correct orientation of the implant axis. Drill the implant bed to the final preparation depth with the twist drill TD230. If necessary, correct the orientation of the implant axis.

Use depth gauge DP230 to check the implant axis and preparation depth. Take an x-ray at this time, especially if the vertical bone volume is reduced. The depth gauge is inserted into the drilled hole and allows a visual assessment of the hole in relation to the anatomical structures.

**3. Widening the implant bed to  $\varnothing$  2.85 mm**

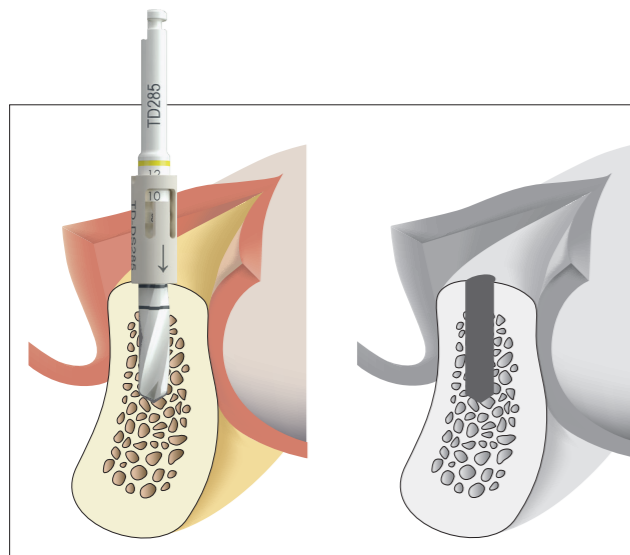

Widen the implant bed with twist drill TD285.

**4. Widening the implant bed to  $\varnothing$  3.25 mm**

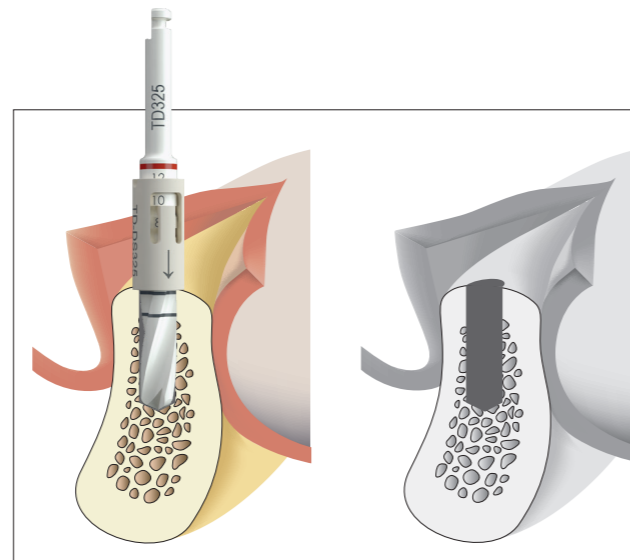

Widen the implant bed with twist drill TD325.

**5. Profile drilling *uneven alveolar ridge***

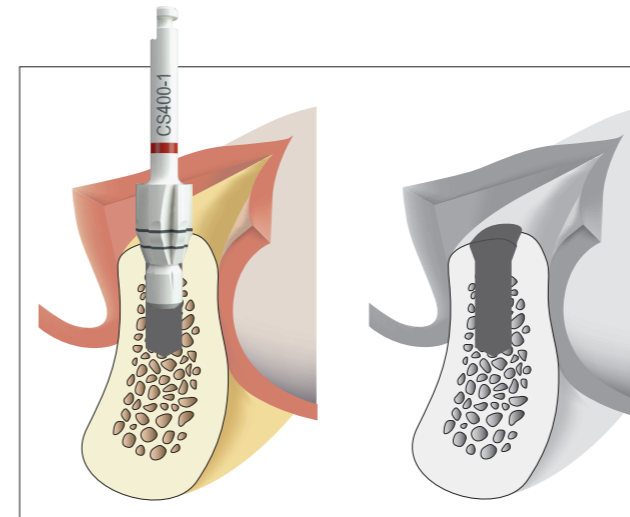

Form the coronal part of the implant bed with the countersink CS400-1 up to the marking on the buccal bone lamella for countersinking the implant shoulder.

**7. Tap**

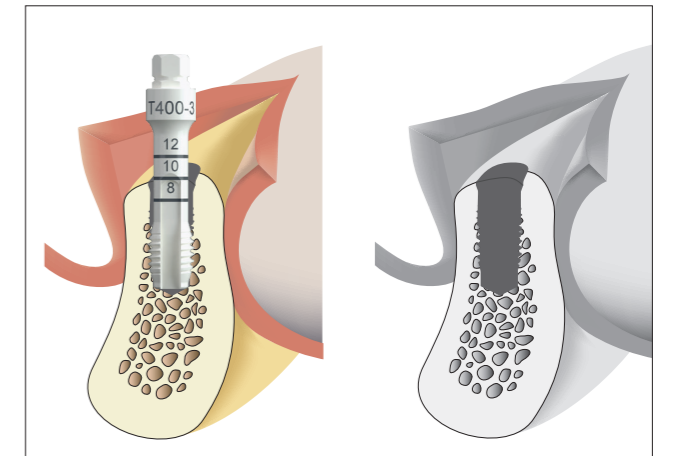

Pre-tap the thread with the T400-3 tap over the entire length of the implant bed preparation for bone class D1+D2.

**6. Profile drilling**

The cortex is widened to the diameter of the implant with the CD400 cortical drill.

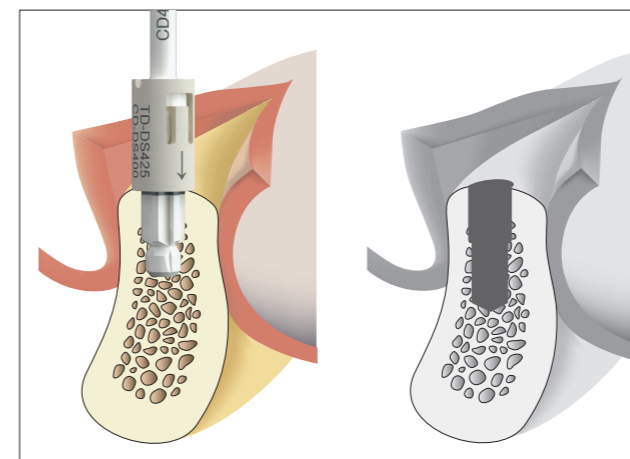

# Drilling protocol

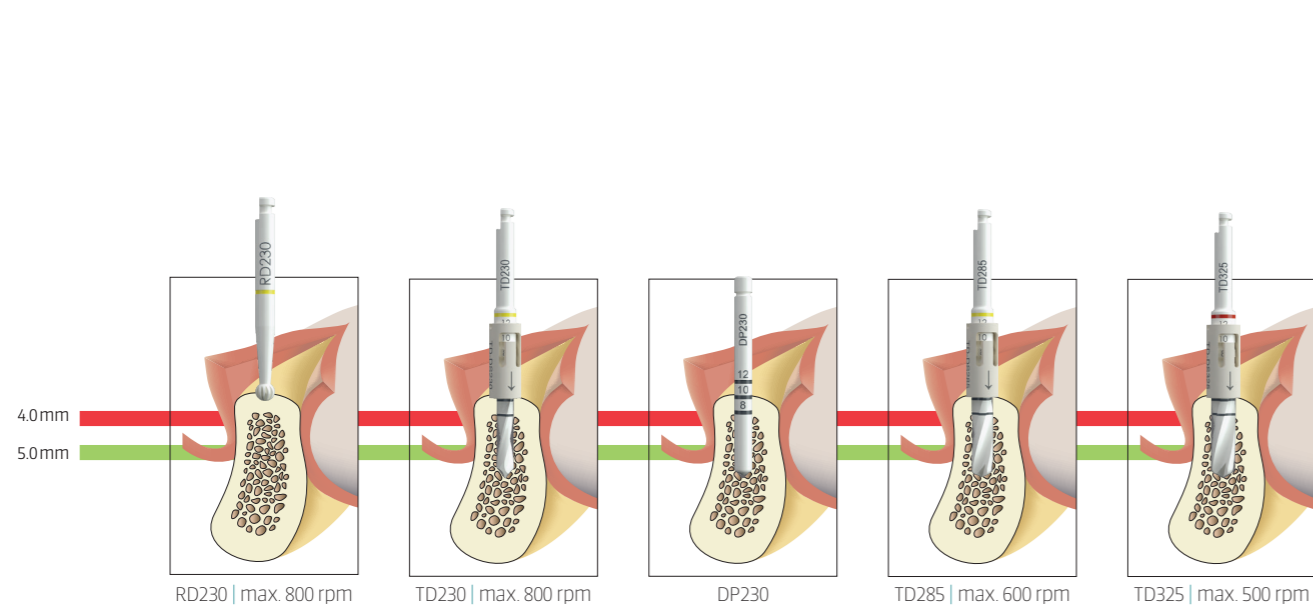

Drilling depth according to the implant length:  
8/10/12 mm

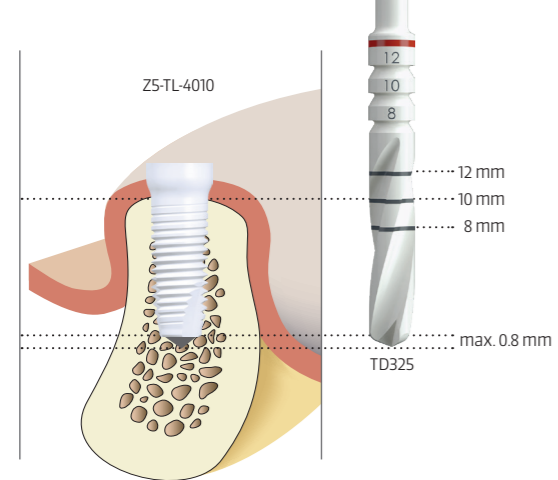

Drills with depth stops

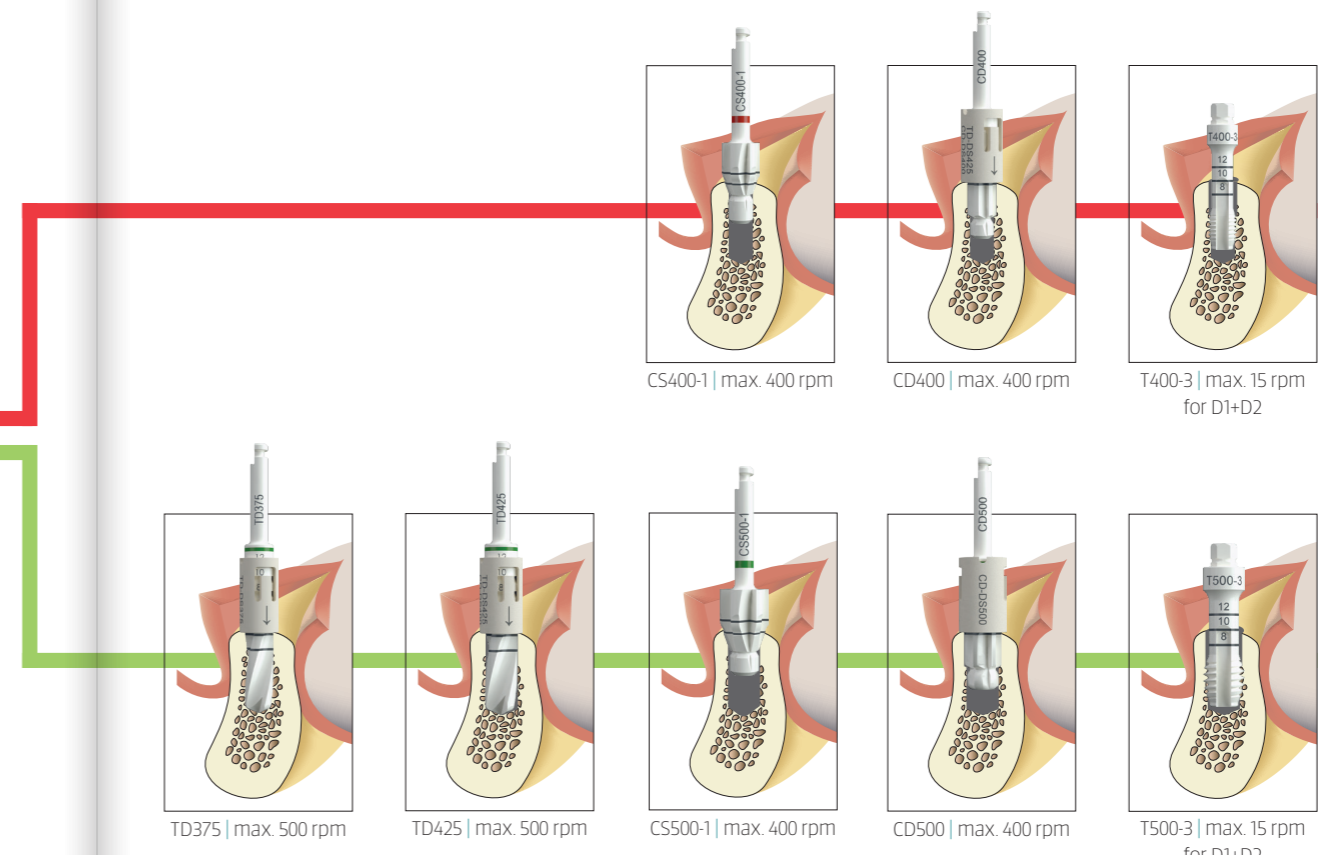

## Specific features of Z5-TL

### Concept

The two-piece, threaded Z5-TL implant is a self-tapping tissue-level implant. The Z5-TL implant has a transgingival portion (shoulder). There is a thread inside the implant in which abutment components such as healing caps, healing abutments and abutments are fixed with the aid of an occlusal screw. After implantation, the inner lumen of the Z5-TL implant is closed with the supplied healing cap (BL-HC) made of radiopaque PEEK (polyether ether ketone) by simply screwing and open healing is aimed for. A selection of standard healing abutments is available for each implant diameter for shaping the soft tissue before the prosthetic restoration. An individual design of the emergence profile can be achieved with the help of the temporary abutment and a temporary crown. Straight, angled and locator abutments are available for the final prosthetic restoration.

During the operation the surgeon decides to which dimension is to be prepared, depending on the bone quality. The drilling protocol must be observed and adhered to.

The optimum insertion torque is in the range of 25–35 Ncm. In the case of uneven alveolar ridges the countersink drill is to be used. For harder bone, a tap should be used to avoid torques of over 35 Ncm when inserting. The twist drills have a depth stop to ensure safe and precise preparation of the implant tunnel.

### Implant removal from the sterile packaging

After opening the secondary packaging, removing the sterile inner blister and open the sealed lid. The white implant holder is rotated clockwise, and the implant is now easily accessible.

The implant driver is a two-piece component. The transfer-piece (TP-SNS) is inserted into the preferred adapter (ZT-HA-9, ZT-RA10-9, ZT-RA20-9) until it clicks into place.

Firmly press the corresponding adapter with the TP-SNS into the implant, taking into account the hexagon. Now the implant can be removed and inserted into the prepared osteotomy. After insertion, the implant driver must be removed again.

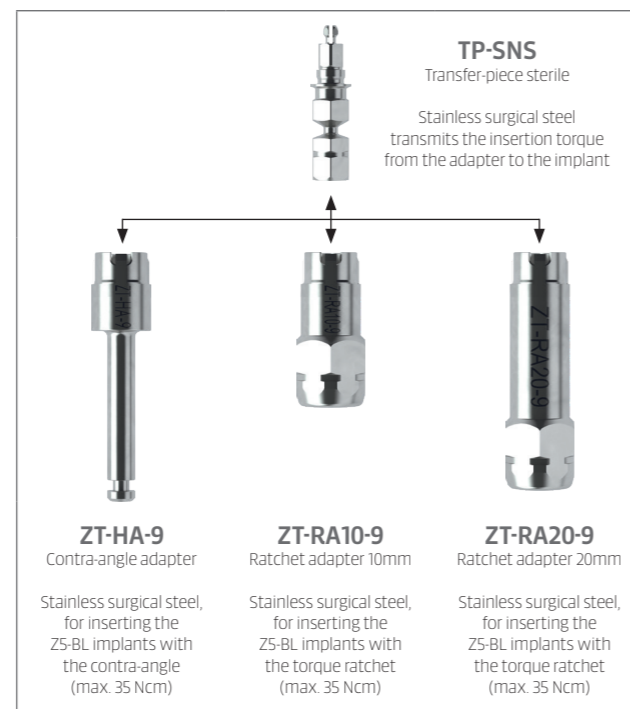

The alignment of the angled abutment can be defined with the transfer-piece. The hexagon on the ratchet adapter and transfer-piece correspond to the six sides of the internal geometry, as highlighted. The angled abutments overlap the hexagonal surface.

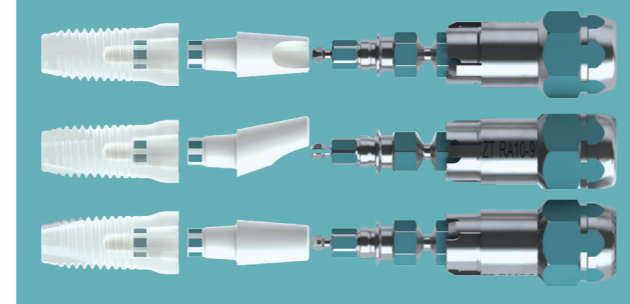

### Implants

A total of six different Z5-TL implants are available. Two diameters, 4.0 and 5.0 mm, each in lengths of 8, 10 and 12 mm.

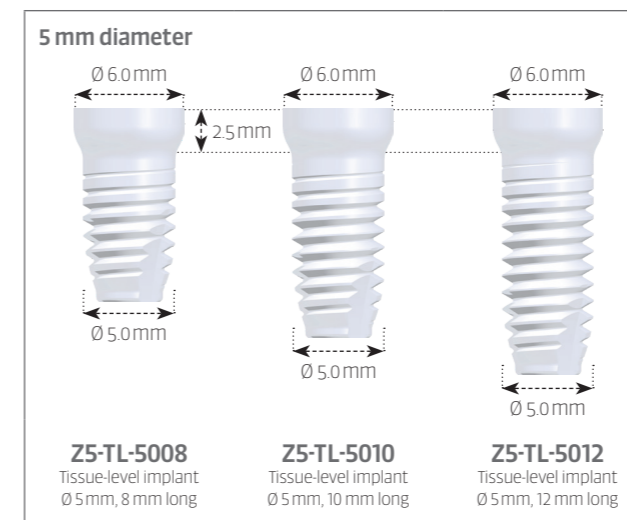
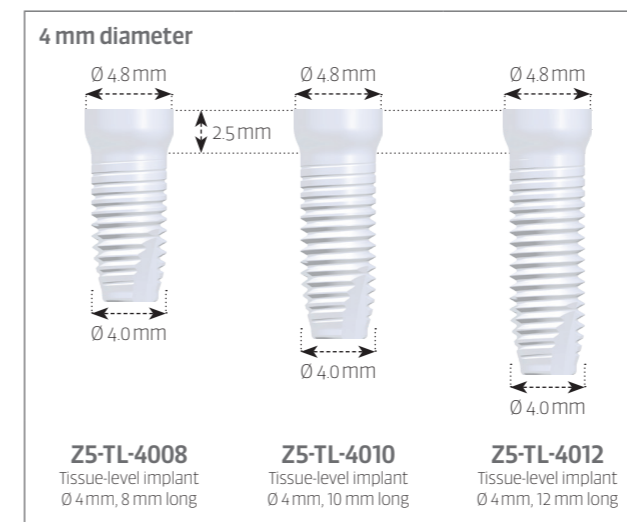

### Healing phase

After implantation, the inner lumen of the Z5-TL implant is closed with the supplied healing cap (BL-HC) made of PEEK (polyether ether ketone) with simple, manual screwing using the screwdriver SD-T6-S or SD-T6-L. Whenever possible, open/transgingival healing should be sought. A good wound closure with tightly fitting gingiva is important.

### Protective measures during the healing phase

No forces may be exerted on the transgingival healing Z5-TL implants.

### For protective devices:

- if the tooth gap will be closed during the healing phase e.g. with a Maryland Bridge, thermoplastic clasp denture
  - or a protective splint
- keep a space of 1.5–2.0 mm between protective device and the Z5-TL implant in order to ensure a load-free healing of the implant.

Please note that the (TL-TA0060) temporary abutment is only intended for use after the healing phase.

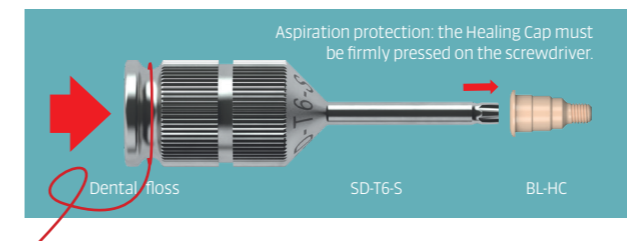
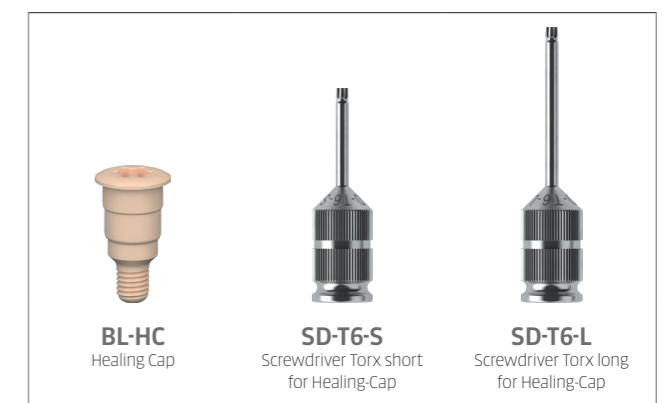

### TORX SCREWDRIVER FOR HEALING CAP

To prevent accidental swallowing of the screwdriver or the Healing Cap, the screwdriver should be secured with a dental floss loop and the Healing Cap socket must be firmly pressed on the screwdriver.

## Removing the implant from the packaging

All Z-SYSTEMS implants are delivered in a sturdy cardboard box, as well as the package insert and three removable label strips for documentation. Inside is an outer blister (secondary packaging), with the inner blister (primary packaging) and the implant, as

- 1** Connect the TP-SNS to the preferred adapter. Before pushing down the adapter on the transfer piece, assure correct alignment of the hexagon. A click is heard when the adapter is attached correctly.
- 2** Carefully apply light pressure to stabilize the white insert.
- 3** Open the sealed lid
- 4** Turn the implant holder counterclockwise
- 5** Slide the transfer piece into the implant with a slight rotational movement. A click will be heard when the transfer piece is properly attached.
- 6** For safe removal, ensure that there is no gap between the TP-SNS and the implant shoulder
- 7** Remove the implant from the insert by hand or by attaching the ratchet or handpiece

### Implant placement

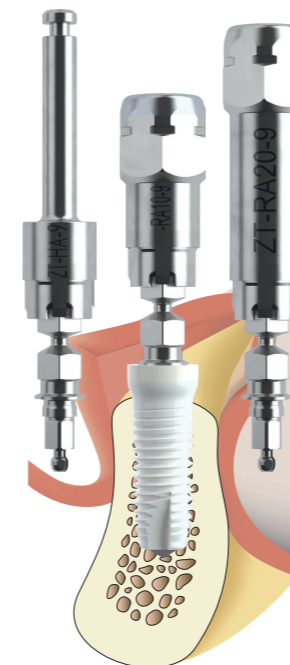

Transfer-piece TP-SNS driven by:  
ZT-HA-9 | ZT-RA10-9 | ZT-RA20-9

Insertion speed (rpm)	15
max. torque	25-35

**USER TIP:**  
Turn the implant slightly to the left before insertion. The thread noticeably engages in the osteotomy and then follows the threads in a clockwise direction as it is inserted.

### Transfer-piece for Z5-BL/-TL Implants

- Retentive notch**
  - to ensure secure retention to adapter i.e. handpiece or ratchet
- Predefined breaking point**
  - to ensure excess torque is not applied to the implant.
- Abutment alignment indicator**
  - Alignment aid for ideal prosthetic abutment orientation
  - Congruent hexagon (Implant - TP-SNS - Abutment)
- Retentive notch**
  - to ensure secure retention to adapter i.e. handpiece or ratchet after failure of the predefined breaking point
- Snap feature/Retention**
  - to ensure secure retention of the implant
  - Detaches with Adapter after implant insertion.

### Implant Driver Removal

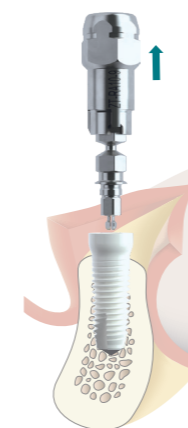

After the implant placement, remove the transfer piece from the implant with the adapter still mounted completely.

### Removal of a broken Transfer-piece



The transfer-piece is provided with a predetermined breaking point to prevent excessive tightening torque. If the transfer-piece breaks during insertion, one fragment remains in the implant and one in the adapter. To extract the implant, simply take out the broken transfer-piece part from the adapter with tweezers, re-insert the adaptor on the transfer-piece part in the implant. Counterclockwise turns will remove the implant. To ensure an insertion torque of 35 Ncm, the implant bed preparation must be checked and re-prepared, to avoid bone overcompression.

### Implant extraction after breaking the pre-defined breaking point to check the implant bed preparation



## Postoperative recall protocol

### Postoperative recall protocol

The following postoperative checks should be carried out at the intervals indicated:

Regular hygiene examinations (depending on the oral hygiene of the patient) up to the beginning of the prosthetic restoration.

Consultation with the surgeon to determine the recall during the first 6–8 weeks of the healing phase. Depending on the case, further conditioning of the soft tissue can be performed with the aid of a healing abutment before the final impression is taken.

The patient should be instructed to contact the practice immediately in the event of any complaints. A prophylactic check should be carried out 14 days and 6 weeks after implantation, at the latest however after three months.

### Successful integration:

- No peri-implantitis
- No clinically noticeable loosening of the implant
- No pain in the vicinity of the implant
- No radiographic visible peri-implant gap

## 3 Prosthetic concept

3.1	Healing abutments	34
3.2	Fixing the abutment with Z5-TL implants	35
3.3	Impressions with the Z5-TL implant	37
3.4	Model fabrication	38
3.5	Temporary care of Z5-TL implants	39
3.6	Restoration with a laboratory-manufactured long-term temporary restoration after osseointegration	40
3.7	Final restorations on Z5-TL implants	41
3.8	Prosthetic restoration of Z5-TL implants	42
3.9	Prosthetic restoration of Z5-TL implants in the edentulous jaw	43
3.10	Prosthetic aftercare of the Z5-TL implants	46
3.11	Cementing of restorations on Z5-TL implants	47
3.12	Prophylaxis for Z5-TL implants	48
3.13	How to remove a ceramic screw fragment from a ceramic implant	49

## Healing abutments

A healing abutment is available for each implant diameter for shaping the soft tissue before the prosthetic restoration. These are screwed into the implant using a screwdriver and the BL-OST basal screw. An individual design of the emergence profile can be achieved with the help of

the temporary abutment and a temporary single-tooth restoration. The healing abutments and the temporary abutment are supplied non-sterile and must be sterilised before use on the patient.

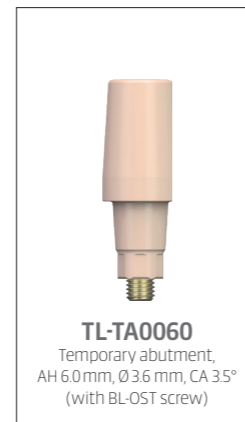
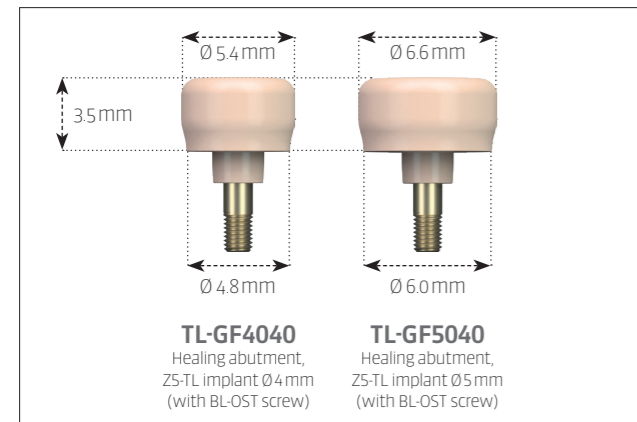

## Fixing the abutment with Z5-TL implants

The abutments should be selected between the dentist and dental technician, taking into account the previous prosthetic planning. The implant axis, the abutment height and the occlusion concept must be taken into account.

All abutments are supplied non-sterile and must be sterilised before use by the patient.

The following abutments are available:

- Straight standard abutments in two different abutment heights for cementable single-tooth crown and bridge restorations.

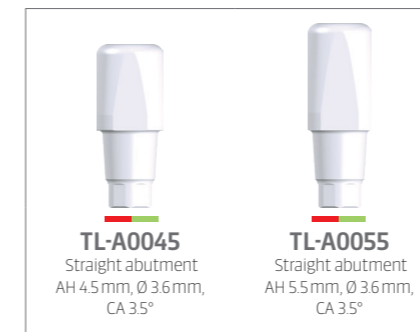

- 15° angled abutments in two different abutment heights for cementable single-tooth crown and bridge restorations.



- Straight and angled Zloc abutments in three different abutment heights for removable anchoring of implant-supported full dentures in the edentulous jaw.

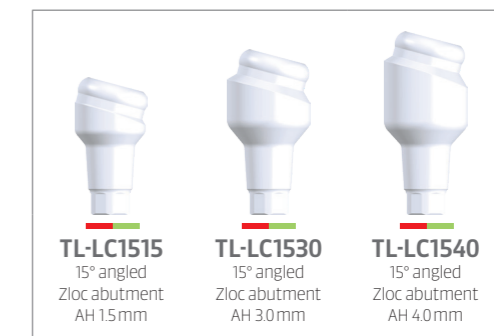
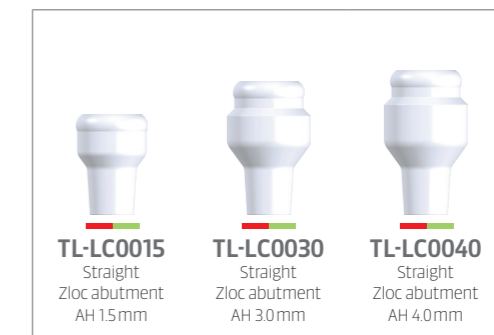
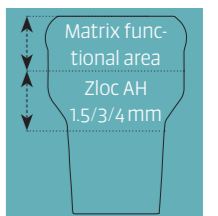

### Explanation of abbreviations:

- ↗ Angle dimension
- ∅ Platform diameter
- GH Gingiva height
- AH Abutment height
- CA Cone angle

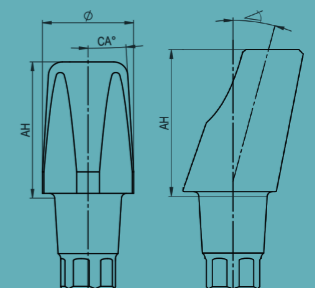

Meaning of the colors: red = Ø 4 mm, green = Ø 5 mm

**Fixing the abutments**

Firmly press the abutment into the implant body by hand. Make sure that the abutment engages in the hexagon.

The connection between abutment and implant is secured by screwing a basal screw into the internal thread of the implant body. A short as well as a long screwdriver are available for the basal screws (SD-BS-S and SD-BS-L). The maximum permissible tightening torque value is reached when the handle of the screwdriver is turned off.

The thread is reversible and can be loosened again. In addition, if necessary, the cone disconnect instrument (BL-CD) may also be used to remove the abutment from the implant.



To prevent accidental swallowing of the screwdriver pin or its handle, both parts should be secured with a dental floss loop.

**Loosening the abutment**

Since the conical implant-abutment connection has a very high fitting accuracy, there is a positive fit between implant and abutment. To be able to loosen the abutment safely again, the removal instrument (BL-CD) must be used.



**Basal screw**

Two different types of screws are available. A ceramic basal screw (BL-OSC-H) or a gold anodized titanium basal screw (BL-OST) is available. In order to reach the correct torque value, both screw types, ceramic and titanium, must be tightened until the handle of the disposable screwdriver turns off.

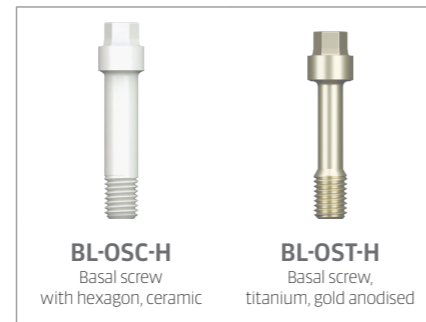

The provisional abutment TL-TA0060 can be used until final restoration, by using the Basal screw BL-OST and the screwdriver BL-SD-ST or BL-SD-LT - with a maximum tightening torque of 10-15 Ncm.



Impressions with the Z5-TL implant

Precise and rotationally stable transfer parts are available for impression taking at implant level. An impression post for the open impression (TL-IP-O), and a scan body for the digital impression (TL-SB).

The laboratory analogues TL-L40/50 is available for a conventional reconstruction on the gypsum model.

**Note regarding TL-SB**

Z-SYSTEMS cannot currently guarantee the provision of individual abutments. Z-SYSTEMS does not assume any guarantee for externally manufactured parts on original Z-SYSTEMS parts.

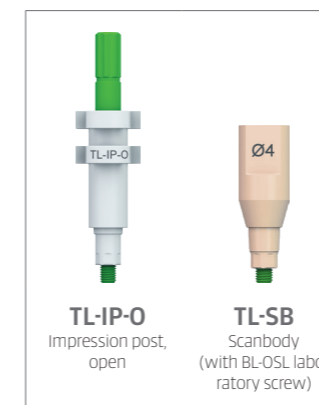
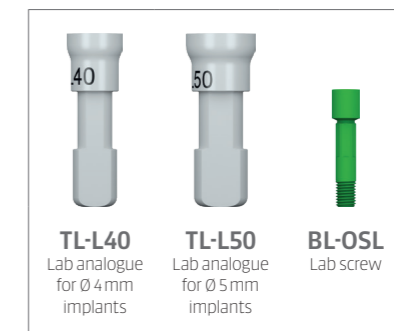

## Model fabrication

### Fabrication of the master model

Position and fix the matching Lab Analog (TL-L40/TL-L50) to the impression using the guide screw. Hand-tighten the guide screw or by screwdriver (BL-SD-ST/LT).

A gingival mask should always be used to ensure that the emergence profile is optimally contoured. Fabricate the master cast.

#### Note:

- Open-tray impression procedure requires a custom-made tray with perforations.
- Impression posts and laboratory analogues are intended for single use to ensure optimal fit and precise impression taking for each patient.

**CAVE:** Prior to the fabrication of the master model it must be established which lab analogue is to be used - TL-L40 or TL-L50.

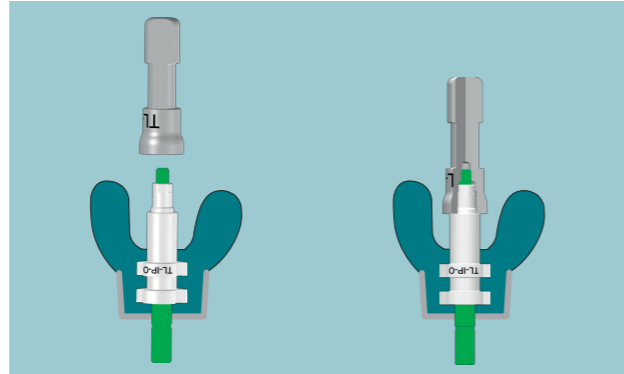

## Temporary care of Z5-TL implants

### General note

The general information on implant-supported restoration applies to the temporary restoration of Z5-TL implants after the healing phase.

Occlusion contacts must always be set so that a simple shim-stock foil can be pulled through interocclusally with slight resistance in the final bite position with maximum intercuspitation. Occlusion contacts should be point-shaped. Flat contacts must be avoided. A group function must be aimed for to relieve a single implant in the canine position.

If temporary restorations are to remain in place for a longer period of time, a close inspection of the firm hold and the static and dynamic occlusion and the periodontal conditions with any appropriate corrections and prophylactic sessions must be ensured. Temporary restorations on Z5-TL implants must have a passive fit.

### Direct temporary restoration

Two different procedures are recommended for the fabrication of direct temporary restorations on Z5-TL implants in the mouth:

- Fabrication of a temporary restoration using an anatomic impression taken directly in the mouth
- Restoration with egg shell temporary

## Restoration with a laboratory-fabricated long-term temporary restoration after osseointegration

If a temporary restoration on Z5-TL implants is intended to stay in place for a longer period (several months), it is recommended to use laboratory-fabricated, framework-reinforced, long-term temporary restorations for stability reasons. The laboratory requires precise impressions for their fabrication.

The long-term temporary restoration must be completely stress-free and must have sufficient space for the placement of cement. Occlusion and dynamic occlusion must be precisely adjusted.

### Procedure

- Check the passive fit of the long-term temporary restoration
- Check the aesthetics, form, phonetics
- Check the occlusion and dynamic occlusion
- Cement

## Final restorations on Z5-TL implants

### General note

Z5-TL implants can be restored with all restorative materials used in modern dentistry.

In addition to all-ceramic restorations, composites, metal restorations and combinations (VMK) are also conceivable. All restoration types are permanently cemented in the conventional manner.

Adhesive extraoral cementation of the restoration to Z5-TL abutment/s is not allowed, to avoid inadequate friction fit connection between the abutment and implant. When restoring Z5-TL implants, the generally applicable guidelines for the planning and fabrication of implant-supported prosthetics must be observed. Particular care must be taken to ensure that the restoration is free of tension.

The static, occlusal contact of the restoration must be kept weak in relation to the contacts of permanent teeth. The movement of permanent teeth must be taken into account, particularly with single-tooth restorations. Dynamic occlusal contacts on the restoration must be avoided. A group function must be aimed for to relieve a single implant in the canine position. A sufficient number of the supporting abutments and a statically favourable distribution must be ensured, as well as good cleaning possibilities.

### Indication for the final prosthetic restoration of Z5-TL implants

The following clinical or radiographic findings indicate that the final prosthetic restorations can be fitted:

- No peri-implantitis
- No clinically noticeable loosening of the implant
- No loosening when attempting to unscrew (max. 15 Ncm/ anaesthesia)
- No pain in the vicinity of the implant
- No radiographic visible peri-implant gap

## Prosthetic restoration of Z5-TL implants

**The valid general guidelines for the fabrication of fixed restorations on implants must be observed on Z5-TL implants. This applies in particular to the static and dynamic occlusion and the periodontium-prophylactic design of the restoration.**

### Indication of single-tooth restoration on Z5-TL implants

Z5-TL implants allow a restoration with fixed single-tooth crowns in the anterior and posterior regions.

The indication guidelines for implant selection must be observed. Furthermore, the instructions for restorations on Z5-TL implants with regard to static and dynamic occlusion, the periodontium-prophylactic design of the restoration, as well as the valid general guidelines for the fabrication of fixed restorations on implants must be observed.



Single-tooth restoration of a front tooth with a Z5-TL implant

### Restoration of interdental gaps on Z5-TL implants

Fixed restorations can be placed on Z5-TL implants to close interdental gaps. Please note the preoperative selection of Z5-TL implants according to the Z-SYSTEMS indication guidelines and the sufficient number of abutments according to generally applicable prosthetic guidelines.

The mesial and / or distal extension of the restoration is not permitted under any circumstances. The integration of Z5-TL implants in composite bridges requires the exact observance of the corresponding recommendations of the implantological societies.

## Prosthetic restoration of Z5-TL implants in the edentulous jaw

### Restoration of Z5-TL implants with a bar construction

When planning a prosthetic restoration of Z5-TL implants using bar construction and removable prosthesis, the indication guidelines for implant selection must be observed. Number and location of implants (Z-SYSTEMS recommends 6 implants in the upper jaw, 4 implants in the lower jaw, min. 5 mm diameter) and the design of the prosthesis body and occlusion should depend on anatomical, functional and hygienic aspects.

#### The task of a bar restoration

- Stabilisation and primary blocking of the implants
- Securing the prosthesis against pulling and levering forces
- Thrust distribution
- Resilience compensation through degrees of freedom

### The relining of an implant-supported bar prosthesis

Hybrid prostheses with resilient anchoring elements must be checked in a recall examination approximately every three months, to remedy any damaging movement of the prosthesis at an early stage using appropriate measures (such as relining).

### Restoration of Z5-TL implants with a telescopic construction

In principle, the Z5-TL implants can be restored with telescopic constructions in combination with removable prostheses and bridges. However, there is an increased risk of forces not applied through the axis (especially high shear forces) acting on the implants. The abutments must be distributed so that at least one telescope is located at the distal end of the prosthesis (masticatory centre) so that no resiliencies act on the implants. A minimum implant diameter of 4 mm and a minimum number of 4 implants in the mandibular and 6 implants in the maxilla must be complied with. The integration of Z5-TL implants in telescopic construction requires the exact observance of the corresponding recommendations of the implantological societies.

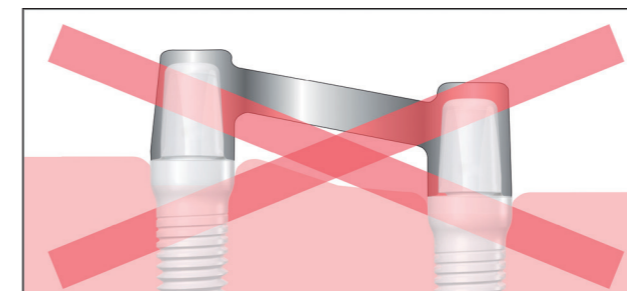

Schematic diagram: No inclined arrangement of the bar link



Schematic diagram

### Prosthetic restoration of Z5-TL implants with Zloc abutments

The new fabrication of the prosthesis is always recommended as part of the overall planning or after implant restoration.

When fabricating the overdenture, please observe the detailed working instructions of the manufacturer Valoc ([www.valoc.ch](http://www.valoc.ch)) for the assembly of Novaloc™ matrices.

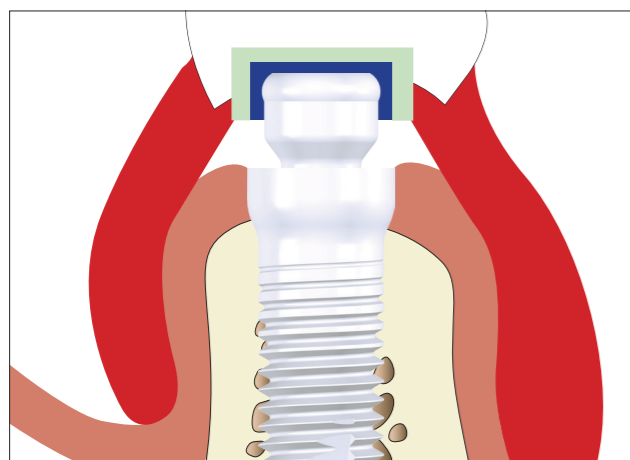

Schematic diagram: Z5-TL implant, Zloc abutment TL-LC0015, Novaloc™ matrix and prosthesis cross-section.



Novaloc™ PEEK matrix, manufacturer: Valoc ([www.valoc.ch](http://www.valoc.ch))

### Matrices

For prosthetic restoration of Z5-TL implants with locator-type abutments only original Novaloc™ matrices of the manufacturer Valoc ([www.valoc.ch](http://www.valoc.ch)) are recommended.

Matrix housings are available from PEEK or titanium. Color-coded retention inserts are available with different retention values (red extra light/white light/yellow medium/green strong/blue extra-strong). The retention value (pull-off strength) can be varied easily by simple exchange of the retention insert. Please follow Valoc's ([www.valoc.ch](http://www.valoc.ch)) manufacturer's instructions.

When gluing the Novaloc™ matrix into the prosthesis chairside, under no circumstances may plastic flow between the matrix and the implant abutment. This can be ensured by placing a thin foil or a rubber dam between the abutment and the matrix. Sufficient space must be available for both the matrix and the plastic (preoperative prosthetic planning!).

### Try-in of the overdenture

The try-in should first take place without the retention elements built into the Novaloc™ matrix. In the first step, check the fit of the prosthesis on the gingiva and the occlusion. In the second step, the prosthesis is tried on with built-in retention elements and the retentive force is adjusted.

### Impression taking

The impression can be taken with the Z5-TL impression components or with the Novaloc™ impression cap. A Novaloc™ forming/fixing matrix (impression cap) is available for impression taking. Please follow the relevant instructions of the manufacturer Valoc ([www.valoc.ch](http://www.valoc.ch)).

#### Impression taking by Z5-TL impression components

- Impression with tissue level impression components
- Master model production with the lab analog (TL-L40/TL-L50)
- Fix the locator-type abutment with the laboratory screw into the lab analog (TL-L40/TL-L50)
- place the Novaloc™ processing spacer\* on the locator-type abutment
- fabrication of the prosthetic restoration

#### Impression taking by Novaloc™ forming/fixing matrix\*

- Fix the locator-type abutment with occlusal screw in the implant
- Put on the Novaloc™ forming/fixing matrix\*
- take impression
- Master model production with straight or angled Novaloc™ model analogue\*
- place the Novaloc™ processing spacer\* on the locator-type abutment
- fabrication of the prosthetic restoration

\* Please follow the relevant instructions of the manufacturer Valoc ([www.valoc.ch](http://www.valoc.ch)).

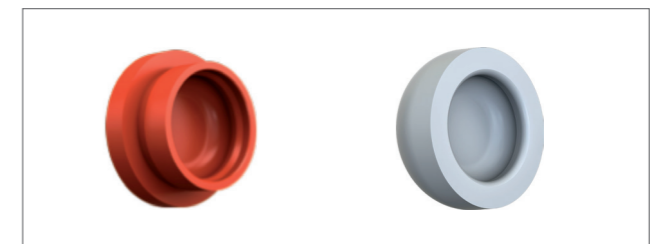

Left: Novaloc™ forming/fixing-matrix, right: Novaloc™ processing spacer  
Manufacturer: Valoc ([www.valoc.ch](http://www.valoc.ch))



Left: Novaloc™ model analogue blue, right: Novaloc™ Model analogue angled 15°  
Manufacturer: Valoc ([www.valoc.ch](http://www.valoc.ch))

## Prosthetic aftercare of the Z5-TL implants

Regular prosthetic aftercare of Z5-TL implants is necessary as with all implant systems. As individual factors such as the patient's oral hygiene, cooperation, etc. play a major role in determining regular prosthetic aftercare, the interval proposed here can only be regarded as a guideline.

### On the day of final placement of the restoration

- Repeat check for impression material residues
- Check the cement in the sulcus area
- Static and dynamic occlusion check
- Oral hygiene instruction
- X-ray examination

### 1 day after placement of the restoration

- Check the cement in the sulcus area
- Static and dynamic occlusion check
- Oral hygiene instruction

### 3 months after placement of the restoration

- Check for plaque
- Static and dynamic occlusion check
- Hygiene check; if necessary reinstruction and motivation
- Performance of a prophylaxis
- For removable prosthetic restorations, check resilience and perform relining if necessary

### 6 months after placement of the restoration

- Check for plaque
- Static and dynamic occlusion check
- Hygiene check; if necessary reinstruction and motivation
- X-ray examination
- Performance of a prophylaxis
- For removable prosthetic restorations, check resilience and perform relining if necessary

> **Check-up every 6 months**

> **Regular prophylaxis**

## Cementing of restorations on Z5-TL implants

### General note

The following points must be observed when fixing temporary or final restorations on Z5-TL implants:

- Relative drainage of the working area
- Completely remove blood and/or saliva
- Cement residues must be completely removed
- Clean the peri-implant sulcus completely of cement residues (probe, superfloss)
- Temporary cementation of final bridge constructions carries the risk of a one-sided loosening of a bridge anchor with an increased risk of a possible fracture of the bridge or abutment ceramic.

### Final cementing on Z5-TL implants

Z-SYSTEMS recommends the use of cements for final cementation that are suitable for zirconium oxide cementation. Zirconium oxide cannot be roughened intraorally by known adhesive systems.

**NOTE: The temporary cementing of final restorations is not recommended.**

Z-SYSTEMS accepts no liability for incorrect use of fastening systems or damage to the prosthetic restoration and/or to the implant itself resulting therefrom.

## Prophylaxis for Z5-TL implants

Zirconium oxide has a very low affinity for plaque. Therefore, compared to other materials used in dentistry, there is very little plaque on Z5-TL implants. Nevertheless, regular and adequate prophylaxis is also indispensable for Z5-TL implants.

Due to their special material and design, some points deviating from the usual prophylaxis guidelines for implants must be observed with Z5-TL implants.

**CAVE:** Use only Teflon-based hand scalers and currettes for cleaning Z5-TL implants.

Rinsing solutions based on chlorhexidine and/or alcohol can be used in the short-term without concern. These solutions are not recommended for long-term use due to possible discoloration of the tooth structure and cement gaps.

Do not use ultrasound-operated, metallic cleaning aids to clean Z5-TL implants. Always avoid the application of ultrasound to Z5-TL implants through metallic carriers. Improper use and application of ultrasound can cause lasting damage to the surface of the Z5-TL implant.

When working with metallic cleaning aids (ultrasound-operated scalers or hand-currettes or scalers) there is the possibility of metallic abrasion on the implant surface. This abrasion is difficult or impossible to remove.

Do not use abrasive prophylaxis pastes to clean Z5-TL implants. A powder/water jet cleaner (Air-Flow®) is not suitable for cleaning Z5-TL implants.

## How to remove a ceramic screw fragment from a ceramic implant

If an abutment failure occurs or the instructions for screwing in the ceramic screw are ignored, the ceramic screw (BL-OSC-H) may break. After a fracture a screw fragment ❶ may remain in the internal thread of the Z5-TL implant. Possible fracture situations are shown in the following figure.

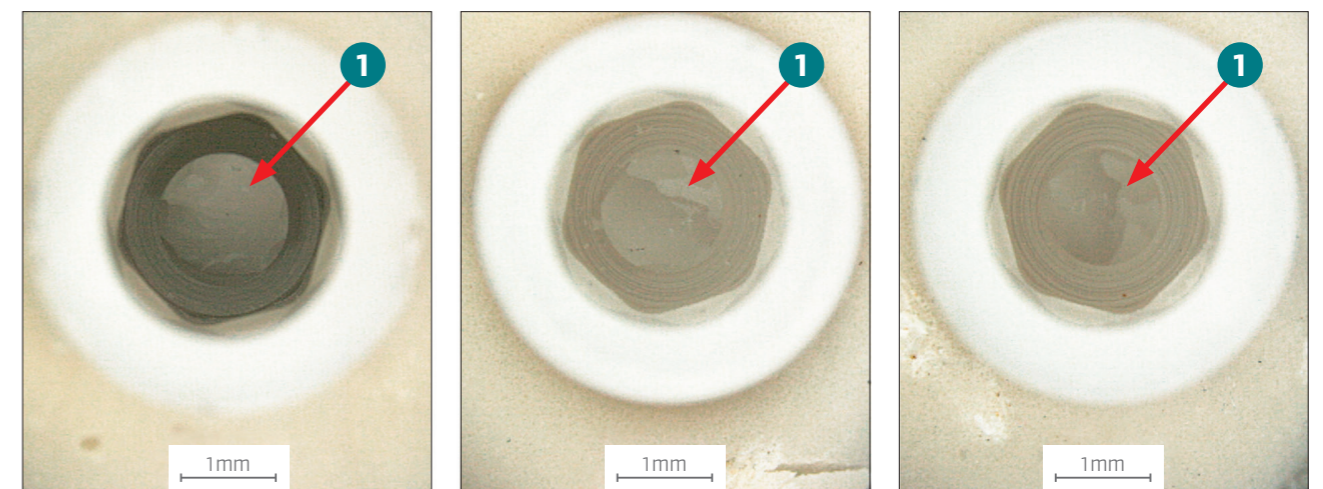

❶ screw fragment (BL-OSC-H)

### Instructions for removing a ceramic screw fragment

#### Clamping the Diamond Grinder Round in the contra angle Handpiece

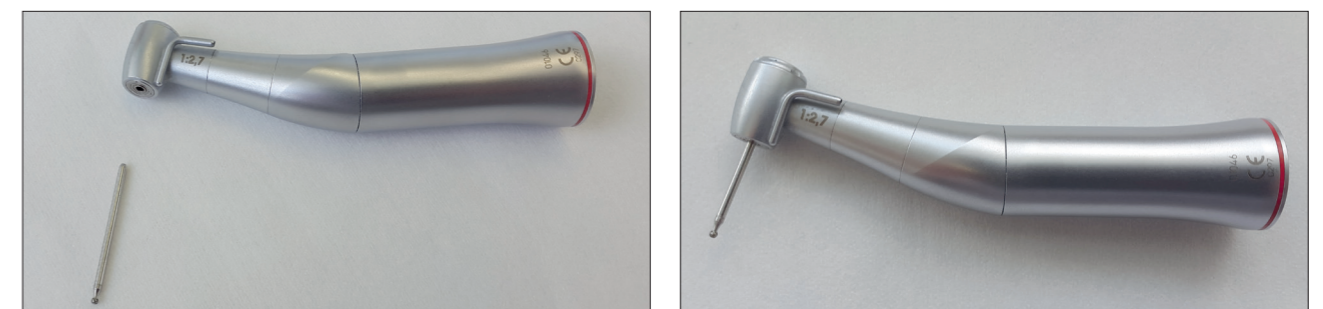

**RECOMMENDATION:**  
Diamond Grinder "round", Medium Grit  
1) Ø 1.4 ± 0.1 mm  
2) L=25 to 30 mm

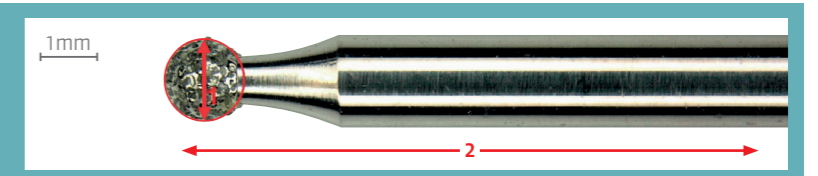

# 3.13

### Program setting of the drive unit:

Speed (rpm)	15-20
Direction of rotation	(M) left-handed counterclockwise

**NOTE:** For the safe turning out a new grade diamond grinder medium grain must be used.

The Diamond Grinder Round is pressed against the screw fragment (red) to unscrew the fragment at 15 rpm, as shown in the figure below with the steps from 1 to 5.

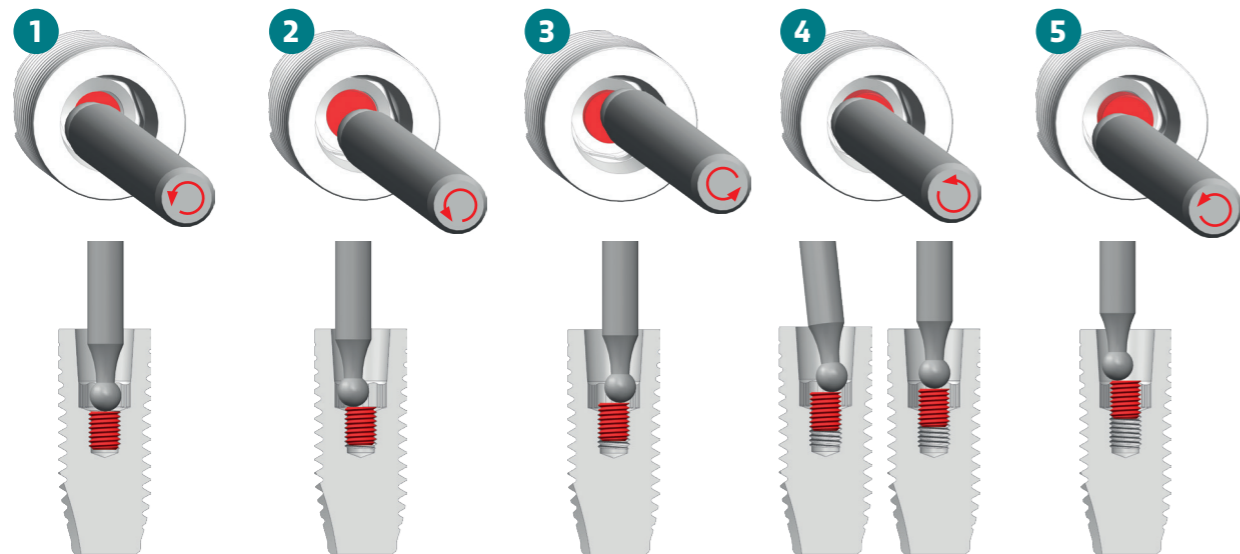

**RECOMMENDATION:**

Unscrew the screw fragment (red) by slightly eccentric guidance of the diamond grinder around the implant axis.

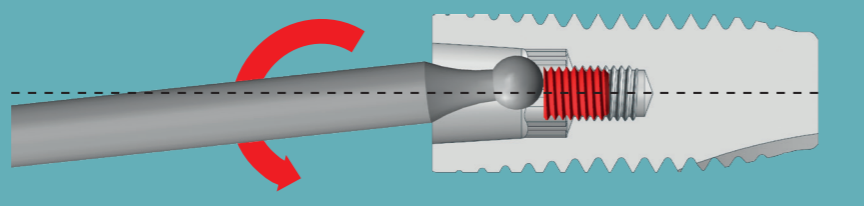



**Z-SYSTEMS**  
ceramic implants

**Headquarters**

**Z-Systems AG** | Werkhofstrasse 5 | CH-4702 Oensingen | Tel. +41 62 388 69 69 | support@zsystems.com

**US Distribution**

**Z-Systems USA Inc.** | 22 Boston Wharf Rd. | Boston, MA 02210 | phone +1 (781) 754-6566 | contact@zsystems.com

[www.zsystems.com](http://www.zsystems.com)